



Automatic Lubrication Pumps

A Complete Family of Air, Electric and Hydraulic Grease and Oil Pumps



PROVEN QUALITY. LEADING TECHNOLOGY.

Pumps for Any Application

The Ultimate in Centralized Lubrication Pumps

From your smallest jobs to your largest machines, Graco pumps are at the heart of any centralized lubrication system. Add a wide variety of quality metering devices, controllers and accessories to get a complete system for nearly any performance, input power or mounting requirement.

With Graco you can be sure every piece of equipment in your plant gets the right amount of lubrication where and when it needs it.



With Graco automatic lubrication systems you get:

- Increased productivity—longer machine life and reduced downtime
- Reduced operating costs—reduced repair labor and component costs
- More efficient lubrication—small, carefully controlled amounts when needed

Graco Automatic Lubrication Systems apply the correct amount of lubrication in the right place at the right time

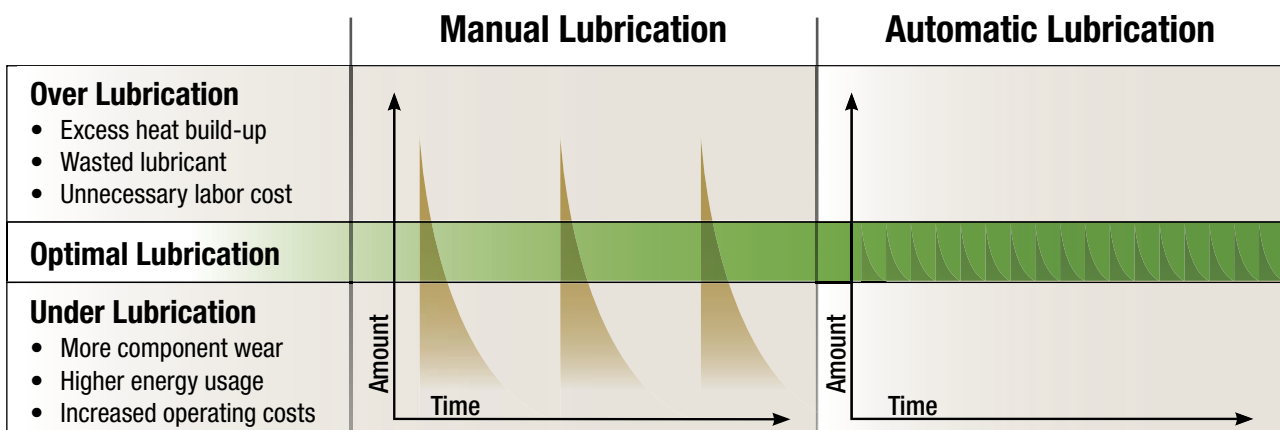

EXAMPLE: Infrequent filling of the bearing results in periods of over and under lubrication

EXAMPLE: Maintain optimal lubrication by replenishing only the lubricant that is used, with small amounts at frequent intervals

Graco Pumps-at-a-Glance

Selecting the Right Pump is Easy!

Choose your pump based on the system injector/metering device, power source and fluid type.

 = Series Progressive

 = Single Line Parallel

 = Dual Line

 = Single Line Resistive

Graco Pump	Metering Device			Power Source						Fluid Type
	SP	SLP	SLR	AC	DC	Pneumatic	Hydraulic	Manual	Mechanical	
E-Series	•					•				Oil or grease
G3™	•	•		•	•					Oil or grease
Injecto-Flo®	•	•		•		•				Oil
Injecto-Flo II		•		•						Oil or fluid grease
LubeMaster®	•			•					•	Oil or grease
LubriSystem™		•				•		•		Oil or grease
Manual Grease Gun	•	•	•					•		Oil or grease
Maxi-Flo®	•			•						Oil
Meter-Flo®	•			•						Oil
Miniature Meter-Flo®	•			•						Oil
Modu-Flo®	•			•	•	•	•			Oil or grease
MSA	•					•				Oil or grease
PH Pump	•	•	•					•		Oil or grease
Thrif-T Luber®			•	•						Oil

Pump Package Example:

Reservoir

A variety of reservoirs are available to fit your specific needs. Choose from cylindrical or rectangular, metal or plastic with sizes up to 30 pounds for grease and 40 pints for oil.

Pump

Choose your pump from the chart above. Graco offers a wide variety to satisfy virtually any application.



Lubrication Management Accessories

Choose from a variety of devices to manage your system including low level- and pressure sensors, cycle indicators and more! (Accessories vary by pump family)

Manifold (available on Modu-Flo)

Manifolds connect the pump and reservoir. Select a package with a built-in manifold, or for more control over your system, select each component separately with a Graco Modu-Flo system. A Modu-Flo system includes a manifold, which allows all reservoirs to fit onto all pumps.

Pneumatic Pumps

MSA-10 and MSA-100

Lubrication Pumps



MSA-100

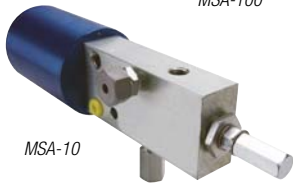

MSA-10

Works With:



MSA Series products are used together with main lubrication supply lines where the pump is fed directly with no additional reservoir required. No reservoir makes the MSA Series ideal for locations that are difficult to reach or undesirable to enter.* Use the MSA-10 for standard applications and the MSA-100 when high operating pressures and larger outputs are required.

Key Features

- Ideal for applications where space is at a premium
- Handles high pressure lubricant feed for direct line intake
- Used with or without a reservoir for the ultimate flexibility

Ordering Information and Technical Specifications

Part No.	Model Description	Max Pump Output/Stroke cm ³ (in ³)	Ratio	Max. Lube Output Pressure, bar (psi)	Lubrication Type
562855	MSA-100 pneumatic pump assembly (no reservoir)	13.1 (.80)	25:1	207 (3000)**	Oil or grease up to NLGI #2
562854	MSA-10 pneumatic pump assembly (no reservoir)	1.97 (0.12)	25:1	100 (1450)	Oil or grease up to NLGI #2

*MSA pumps can be used with standard Trabon reservoirs if desired

**NOTE: Supplied with rupture-to-atmosphere indicator rated to 1450 psi (standard)

For more details see Technical Bulletin #L12850 (MSA 10) and #L12851 (MSA 100) on www.graco.com - Instruction Manuals

Lubrication Pumps

E-Series



#563365 Shown

Works With:



The E-Series pump is a great entry level alternative to standard pneumatic pump products. This all-in-one pump package comes complete with no assembly required and is easy to install. All pump packages include high-pressure rupture disc assembly and lube outlet check valve. The E-Series offers many reservoir options for either grease or oil. Great for any application where price is a concern and installation time is at a premium.

Key Features

- Fast and easy installation—keeps costs at a minimum
- Modular design allows field installation of accessories without disturbing existing plumbing
- Smart pump design with few moving parts ensures long-lasting dependability

Ordering Information and Technical Specifications

Part No.	Model Description	Max Pump Output Per Stroke, cm ³ (in ³)	Ratio	Max. Lube Output Pressure, bar (psi)	Lubrication Type
563365	E-pump with 3 lb plastic cylindrical grease reservoir, low level and pressure gauge	0.49 (0.03)	20:1	138 (2000)	Oil or grease up to NLGI #2
563363	E-pump with 6 lb plastic cylindrical grease reservoir				
563364	E-pump with 6 lb plastic cylindrical grease reservoir, low level				
563361	E-pump with 4 pint plastic rectangular oil reservoir				
563362	E-pump with 4 pint plastic rectangular oil reservoir, low level				
563358	E-pump only				

For more details see Technical Bulletin #L13126 on www.graco.com - Instruction Manuals

Pneumatic Pumps

Injecto-Flo™ AO-1

Lubrication Pumps



Works With:



The AO-1 pneumatic pumps are compact in size, but deliver higher pump output rates with its short pump off time between cycles. Great for applications using piston distributors for oil lubrication. Several reservoir sizes and materials to choose from.

Key Features

- Compact design easily fits into any application
- Built-in vent valve gets you up and working with piston distributors fast—no kits to purchase or assemble

Ordering Information and Technical Specifications

Part No.	Model Description	Max Pump Output/Stroke cm ³ (in ³)	Ratio	Max. Lube Output Pressure, bar (psi)	Lubrication Type
562846	Pump with 10.5 pint metal rectangular reservoir	13 (0.80)	4.5:1	31 (450)	Oil (250-5000 SUS)
562845	Pump with 4.2 pint plastic rectangular reservoir				

For more details see technical bulletin #L12601 on www.graco.com - Instruction Manuals

Lubrication Pumps

LubriSystem™



Works With:



Easy to design, modify and adjust to oil or grease applications large or small! Great for operation with injectors or piston distributors. Rugged construction maximizes your productivity—upgrading to the internal timer control completely automates the system. All packages include internal pressure relief, so no need to install extra parts with additional costs. Combine with LubriSystem injectors for easy, low cost system design solutions.

Key Features

- Ability to serve large systems—up to 100 lube points or more!
- Efficient design promotes increased productivity and less downtime
- Several reservoir choices for both oil and grease applications

Ordering Information and Technical Specifications

Part No.	Model Description	Max Pump Output/Stroke cm ³ (in ³)	Ratio	Max. Lube Output Pressure, bar (psi)	Lubrication Type
563571	Pump, 6 lb. plastic cylindrical grease reservoir	24.6 (1.5)	9:1	25-93 (360-1350)	Grease up to NLGI #1
563572	Pump, 6 lb. plastic cylindrical grease reservoir and low level				Grease up to NLGI #1
563573	Pump, 12 lb. plastic cylindrical grease reservoir and low level				Grease up to NLGI #1
563574	Pump, 6 pint plastic cylindrical oil reservoir				Oil
563575	Pump, 12 pint plastic cylindrical oil reservoir				Oil
563576	Pump, 20 pint plastic cylindrical oil reservoir				Oil
563578	Pump, 12 pint plastic cylindrical oil reservoir and 10 watt low level				Oil
563577	Pump, 6 pint plastic cylindrical oil reservoir and 10 watt low level				Oil
563579	Standard air operated pump body, (no reservoir)				Oil or grease up to NLGI #1

For more details see Technical Bulletin #L12100 on www.graco.com - Instruction Manuals

Pneumatic Pumps

Pneumatic Modu-Flo

Lubrication Pumps



Works With:



The Modu-Flo system is ideal for applications where minimizing downtime is critical. Customizing is easy—just mix and match pumps, reservoir and manifolds in any configuration to meet any application. Replace the pump or reservoir without disconnecting lubrication lines. Choose from a wide variety of pneumatic pump configurations for both oil and grease applications.

Key Features

- Modular system design allows configurations to work in all applications
- Easy to standardize on components and reduce inventory
- Adjustable pump output for fast, convenient customization

Ordering Information and Technical Specifications

Part No.	Model Description	Max Pump Output/Stroke cm ³ (in ³)	Ratio	Max. Lube Output Pressure, bar (psi)	Lubrication Type
563304	ALS-5 pump, single or double acting (no reservoir)	0.16-0.49 (0.01-0.03)	30:1	241 (3500)	Oil or grease up to NLGI #2
563306	ALS-25 pump, single or double acting (no reservoir)				
563308	ALS-50 pump, single or double acting (no reservoir)	0.98-3.93 (0.06-0.24)			

NOTE: Single- and double-acting pneumatic pumps (AL) have the same part number.

For more details see Technical Bulletin #L12000 on www.graco.com - Instruction Manuals

GRACO ADVANTAGE

Accurate and Dependable Lubrication Systems

While critical bearings are hard at work on your machine tool, press and production equipment, Graco's line of centralized and automatic lubrication systems are delivering precise amounts of lubricant at frequent intervals to every lube point—even if they're hard to reach. You'll also get better end results and a higher quality product with the consistent shot accuracy of Graco's metering systems.

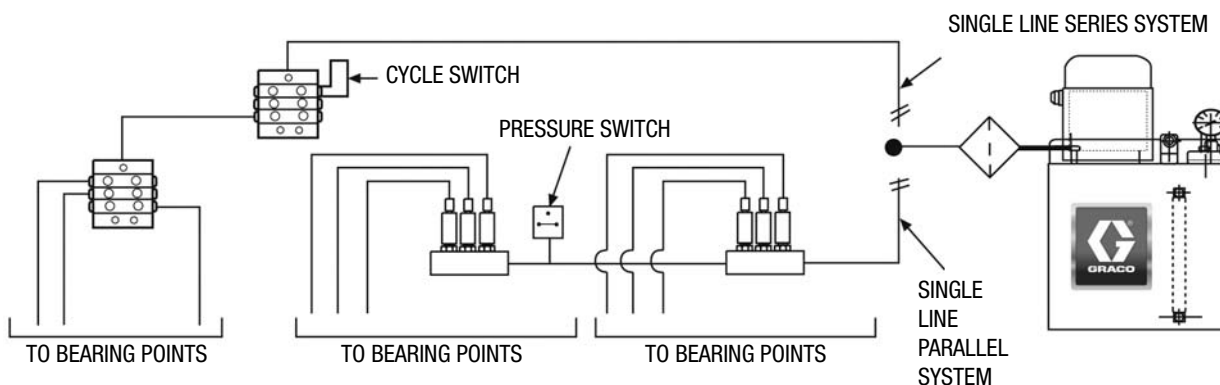

Graco lubrication products help to increase production, reduce downtime and maintenance costs.

Electric Pumps

G3

Lubrication Pumps



Works With:



Changing grease types, changing temperatures and challenging installation requirements are no problem for the G3 electric lubrication pump. With its flexible design, including adjustable pump elements and an ability to work with both injector-based and series progressive systems, G3 is a rugged, cost-effective pump designed to serve multiple markets and applications. The new pump features three control choices, which means added flexibility for easy lube system set-up, operation and troubleshooting. The pump extends machinery life, reduces operating costs and increases productivity for usage in a wide variety of markets, including in-plant manufacturing, mobile on-road and off-road, and wind turbines.

Key Features

- Powerful pumping performance – can be used with your grease of choice, NLGI #000 - #2 and oil
- Advanced flow dynamics – helps to prevent grease separation
- Load minimizing drive – for longer life
- Adjustable stroke pump – ensures a custom fit
- Five reservoir sizes to select from – provides a custom fit
- The most advanced user controls in its class – allows you to customize for your unique needs
- Follower Plate Option
- Available with 2,4,8,12 and 16L reservoirs.

Ordering Information and Technical Specifications

Part of configuration offering. For complete packages, items & accessories see: G3 Selection Guide n° 340706

Part No.	Model Description	Control Type	Max Pump Output Volume cm ³ (in ³)	Max. Operating Pressure, bar (psi)	Lubrication Type
96G002	90-240 VAC, wiper arm, DIN power connector, 2 l reservoir	No control	Adjustable 2 (0.12) 3 (0.18) 4 (0.25)	352 (5100)	Grease Up to NLGI #2
96G003	12 VDC, wiper arm, external low level, 3 pin CPC power connector, 2 l reservoir	No control			
96G005	24 VDC, wiper arm, external low level, 3 pin CPC power connector, 2 l reservoir	No control			
96G007	90-240 VAC, wiper arm, external low level, DIN power connector, 2 l reservoir	No control			
96G033	12 VDC, wiper arm, low level alarm, 3 pin CPC power connector, 2l reservoir	Pro			
96G011	24 VDC, low level, manual run input, wiper arm, 3 pin CPC power connector, 2l reservoir	Pro			
96G012	24 VDC, low level, manual run input, follower plate, 3 pin CPC power connector, 2 l reservoir	Pro			
96G013	90-240 VAC, low level, wiper arm, DIN power connector, 2 l reservoir	Pro			
96G035	12 VDC, wiper arm, low level, 5 pin CPC power connector , single sensor input (cycle/pressure), vent valve, 2l reservoir	Max			
96G031	24 VDC, low level, single sensor input (cycle/pressure), wiper arm, 3 pin CPC power connector, manual run input, 2l reservoir	Max			
96G018	24 VDC, low level, single sensor input (cycle/pressure), vent valve output, manual run input, follower plate, 3 pin CPC power connector, 2 l reservoir	Max			
96G032	90-240 VAC, low level, single sensor input (cycle/pressure), wiper arm, DIN power connector, 2 l reservoir	Max			
96G020	90-240 VAC, low level, single sensor input (cycle/pressure), vent valve output, follower plate, DIN power connector, 2 l reservoir	Max			
96G021	12 VDC, low level, three sensor inputs (combination cycle/pressure), machine count, vent valve output, alarm output, manual run input, wiper arm, DIN power connector, 2 l reservoir	Max			
96G024	24 VDC, low level, three sensor inputs (combination cycle/pressure), machine count, vent valve output, alarm output, manual run input, follower plate, DIN power connector, 2 l reservoir	Max			
96G025	90-240 VAC, low level, three sensor inputs (combination cycle/pressure), machine count, vent valve output, alarm output, manual run input, wiper arm, DIN power connector, 2 l reservoir	Max			

Electric Pumps

LubeMaster

Lubrication Pumps



Works With:



The LubeMaster is a rugged pump package designed for any harsh duty application. The adjustable output and anti-friction drive bearings make it both reliable and efficient. With several reservoir choices and accessories to choose from, the LubeMaster pump can be easily customized to meet virtually all application needs.

Key Features

- Rugged cast iron main body and heavy-duty internal components deliver consistent performance in harsh applications
- Reliable design includes anti-friction bearings for years of trouble-free operation

Ordering Information and Technical Specifications

Part No.	Model Description*	Max Pump Output/ Stroke cm ³ (in ³)	Max Pump Output Volume cm ³ (in ³)	Max. Lube Output Pressure, bar (psi)	Lubrication Type
LM2323	115/230 VAC, 1 PH, 1725 RPM, 20 pint plastic cylindrical oil reservoir, low level, 10:1	0.16 – 0.82 (0.01 – 0.05)	0.16 - 143.41 (0.01 - 8.62)	340 psi (5000 bar)	Oil or grease up to NLGI #2
LM4523	115/230 VAC, 1 PH, 1725 RPM, 20 pint metal cylindrical oil reservoir, low level, 60:1				
LM4533	230/460 VAC, 3 PH, 1725 RPM, 20 pint metal cylindrical oil reservoir, low level, 60:1				
LM5331	230/460 VAC, 3 PH, 1725 RPM, 12 lb plastic cylindrical grease reservoir, low level, 10:1				
LM5521	115/230VAC, 1 PH, 1725 RPM, 12 lb plastic cylindrical grease reservoir, no low level, 60:1				
LM5544	115/230 VAC, 1PH, 1140 RPM, 12 lb plastic cylindrical grease reservoir, low level, 60:1				
LM5644	115/230 VAC, 1PH, 1140 RPM,, 12 lb plastic cylindrical grease reservoir, low level, 60:1-wall mount				
LM6334	115/230VAC, 11PH, 1140 RPM, 20 lb plastic cylindrical grease reservoir, low level, 10:1				
LM6344	115 VAC/1140 RPM, 12 lb plastic cylindrical grease reservoir, 10:1				
LM6524	115/230 VAC, 1 PH, 1725, 20 b plastic cylindrical grease reservoir, low level, 60:1				
LM6534	230/460 VAC, 3 PH, 1725 RPM, 20lb plastic cylindrical grease reservoir, low level, 60:1				
LM6544	115/230VAC, 11PH, 1140 RPM, 20 lb plastic cylindrical grease reservoir, low level, 60:1				
LM7344	115/230VAC, 11PH, 1140 RPM,, 12 lb metal cylindrical grease reservoir, low level, 10:1				
LM7654	230/460 VAC, 3PH, 1140 RPM, 12 lb metal cylindrical grease reservoir, low level, 60:1, wall mount				
LM8334	230/460 VAC, 3 PH, 1725 RPM, 20 lb metal cylindrical grease reservoir, low level, 10:1				
LM8454	230/460 VAC, 3PH, 1140 RPM, 20 lb metal cylindrical grease reservoir, low level, 10:1, wall mount				
LM8531	230/460VAC, 3PH, 1725 RPM, 20 lb metal cylindrical grease reservoir, no low level 60:1				
LM8534	115/230 VAC, 1 PH, 1725 RPM , power prime reservoir assembly, no low level, 60:1				
LM9521	115 VAC/1725 RPM, power prime reservoir assembly, 60:1				

*All pumps are floor-mounted unless noted

Electric Pumps

Miniature Meter-Flo

Lubrication Pumps



Works With:



Designed for use with virtually any type of Series Progressive or Single Line Resistive oil lubrication system. The Miniature Meter-Flo's rugged steel reservoir and motor assembly withstand the toughest applications. Capable of high volumetric output (up to 14 in³/minute) operating continuously at pressures up to 1000 psi (69 bar).

Key Features

- Ideal for smaller series progressive systems requiring continuous lubrication
- Compact and rugged for years of dependable operation in any application
- Several options available to create a complete system using feedback and control

Ordering Information and Technical Specifications

Part No.	Model Description	Max Pump Output Volume cm ³ (in ³)	Max. Lube Output Pressure, bar (psi)	Lubrication Type
MM1111	115 VAC, 12 pint metal rectangular reservoir	16 (1)	0-69 (0-1000)	Oil (160-15000 SUS)
MM1112	115 VAC, 12 pint metal rectangular reservoir (with level switch)			
MM1121	115 VAC, 12 pint metal rectangular reservoir (with pressure Switch)			
MM1122	115 VAC, 12 pint metal rectangular reservoir (with pressure & level switches)			
MM2112	115 VAC, 24 pint metal rectangular reservoir (with level switch)			
MM2122	115 VAC, 24 pint metal rectangular reservoir (with pressure & level switches)			
MM3112	115 VAC, 40 pint metal rectangular reservoir (with level switch)			
MM3122	115 VAC, 40 pint metal rectangular reservoir (with pressure & level switches)			
MM1212	115 VAC, 12 pint metal rectangular reservoir (with level switch)	82 (5)	0-138 (0-2000)	
MM1222	115 VAC, 12 pint metal rectangular reservoir (with pressure & level switches)			
MM2211	115 VAC, 24 pint metal rectangular reservoir (with level switch)			
MM2212	115 VAC, 24 pint metal rectangular reservoir (with level switch)			
MM2221	115 VAC, 24 pint metal rectangular reservoir (with pressure switch)			
MM2222	115 VAC, 24 pint metal rectangular reservoir (w/pressure & level switches)			
MM3211	115 VAC, 40 pint metal rectangular reservoir			
MM3212	115 VAC, 40 pint metal rectangular reservoir (with level switch)			
MM1311	115 VAC, 12 pint metal rectangular reservoir	131 (8)	0-103 (0-1500)	
MM1312	115 VAC, 12 pint metal rectangular reservoir (with level switch)			
MM1322	115 VAC, 12 pint metal rectangular reservoir (with pressure & level switches)			
MM2312	115 VAC, 24 pint metal rectangular reservoir (with level switch)			
MM2322	115 VAC, 24 pint metal rectangular reservoir (with pressure & level switches)			
MM3322	115 VAC, 40 pint metal rectangular reservoir (with pressure & level switches)			
MM1411	115 VAC, 12 pint metal rectangular reservoir	229 (14)	0-103 (0-1500)	
MM1412	115 VAC, 12 pint metal rectangular reservoir (with level switch)			
MM1422	115 VAC, 12 pint metal rectangular reservoir (with pressure & level switches)			
MM2411	115 VAC, 24 pint metal rectangular reservoir			
MM2412	115 VAC, 24 pint metal rectangular reservoir (with level switch)			
MM3411	115 VAC, 40 pint metal rectangular reservoir			
MM3412	115 VAC, 40 pint metal rectangular reservoir (with level switch)			
MM3422	115 VAC, 40 pint metal rectangular reservoir (with pressure & level switches)			

Lubrication Pumps

Injecto-Flo EO-1



Works With:



The EO-1 series electric pump package is designed for any low-pressure, intermittent oil lubrication system where high volume rates are required. Use with any piston distributor metering device for easy-to-install, custom solutions.*

Key Features

- Compact design easily fits into applications where space is limited
- Built-in vent valve gets you up and working with piston distributors fast—no kits to purchase and assemble

Ordering Information and Technical Specifications

Part No.	Model Description	Max Pump Output Volume cm ³ (in ³)	Max. Lube Output Pressure, bar (psi)	Lubrication Type
562837	EO-1 pump, 115VAC, 1PH, 6.3 pint plastic rectangular oil reservoir	200 (12)	40 (580)	Oil ISO VG68 - ISO VG460 or 50-1000 cSt
562839	EO-1 pump, 115VAC, 1PH, 12.6 pint plastic rectangular oil reservoir			
562843	EO-1 pump, 115VAC, 1PH, 12.6 pint plastic rectangular oil reservoir			
562844	EO-1 pump, 115VAC, 1PH, 25.3 pint plastic rectangular oil reservoir			
562849	EO-1 pump, 230/400 VAC, 3PH, 6.3 pint plastic rectangular oil reservoir			
562838	EO-1 pump, 115VAC, 1PH, 7.6 pint plastic rectangular oil reservoir			
562841	EO-1 pump, 230VAC, 1PH, 12.6 pint plastic rectangular oil reservoir			
562842	EO-1 pump, 230VAC, 1PH, 12.6 pint plastic rectangular oil reservoir, return port			
562840	EO-1 pump, 230VAC, 1PH, 15.8 pint plastic rectangular oil reservoir			

NOTE: Motor voltages are 50/60 Hz and single phase.

*Can be used with Injecto-Flo II series piston distributor products

For more details see Technical Bulletins #L12605 and #L12606 on www.graco.com - Instruction Manuals

Lubrication Pumps

Injecto-Flo EO-3



Works With:



A cost effective, low pressure oil solution designed for use with any high volume, intermittent lubrication system. EO-3 packages have a standard integrated controller with LED indicators for a completely automated system. Use with any piston distributor metering devices for easy to install, custom solutions.*

Key Features

- Compact design with integrated control and bright LED's to verify system operation
- Built-in vent valve gets you up and working with piston distributors fast—no kits to purchase and assemble

Ordering Information and Technical Specifications

Part No.	Model Description	Max Pump Output Volume cm ³ (in ³)	Max. Lube Output Pressure, bar (psi)	Lubrication Type
562850	115 VAC, 1 PH, 7.6 pint plastic rectangular reservoir (integrated timer, pressure switch, low level)	12 (200)	350 (25)	Oil ISO VG68 - ISO VG460 or 50-1000 cSt
562847	115 VAC, 1 PH, 12.6 pint plastic rectangular reservoir (no timer, pressure switch, low level)	12 (200)	320 (22)	
562852	115 VAC, 1 PH, 7.6 pint plastic rectangular reservoir (no timer, pressure switch, low level = N.C.)	12 (200)	350 (25)	
562851	115 VAC, 1 PH, 7.6 pint plastic rectangular reservoir (no timer, pressure switch, low level)	12 (200)	350 (25)	
258294	230 VAC, 1 PH, 7.6 pint plastic rectangular reservoir (integrated timer, pressure switch, low level)	24 (400)	435 (30)	
564254	24 VDC, 1 PH, 7.6 pint plastic rectangular reservoir (integrated timer, pressure switch, low level)	12 (200)	350 (25)	
24B430	230 VAC, 1 PH, 7.6 pint plastic rectangular reservoir (no timer, pressure switch, low level)			

All pumps are Low Level N.O. (Normally Open) unless noted above as N.C. (Normally Closed)

*Can be used with Injecto-Flo II series piston distributor products

For more details see Technical Bulletins #L12605 and #L12606 on www.graco.com - Instruction Manuals

Simple Installation—Dependable Operation

Lubrication Pumps

Injecto-Flo II



Works With:



Great versatility in a small package! The Injecto-Flo II's compact design is the ideal solution for automatic lubrication on small and mid-sized machines. Combine with Injecto-Flo II piston distributor metering devices for a complete oil or fluid grease lubrication system. Internal controller with LED alarms is easy to program for any application.

Key Features

- Many control options to choose from to fully automate your lube system
- Use with Graco piston distributors to complete your system
- Dependable high-quality gear pump for years of trouble-free operation

Ordering Information and Technical Specifications

Part No.	Model Description	Max Pump Output Volume cm ³ (in ³)	Max. Lube Output Pressure, bar (psi)	Lubrication Type
122547	230 VAC, 6.3 pint plastic rectangular oil reservoir (no low level, screw cap)	500 (30.51)	30 (435)	Oil (30-1500 cSt)
122551	230 VAC, 6.3 pint plastic rectangular oil reservoir (low level, 1-din, screw cap)			
15U858	230 VAC, 6.3 pint plastic rectangular oil reservoir (low level, 2-m12, 10mm cap)			
122565	230 VAC, 12.7 pint plastic rectangular oil reservoir (no low level, screw cap)			
564138	230 VAC, 12.7 pint plastic rectangular oil reservoir (low level, 1-din, screw cap)			
122576	230 VAC, 12.7 pint plastic rectangular oil reservoir (low level, 2-din, screw cap)			
15U860	230 VAC, 12.7 pint plastic rectangular oil reservoir (low level, 2-m12, 10mm cap)			
122898	230 VAC, 12.7 pint plastic rectangular oil reservoir with control (low level, pressure, two strain relief wiring points, screw cap)	200 (12.20)	40 (580)	Fluid grease up to NLGI 000
15U859	230 VAC, 6.3 pint plastic rectangular oil reservoir (low level, 1-m12, 10mm cap)			
563301	230 VAC, 6.3 pint plastic rectangular grease reservoir (no low level, 10mm cap)			
122582	230 VAC, 6.3 pint plastic rectangular grease reservoir (low level, 1-din, screw cap)			
557547	230 VAC, 6.3 pint plastic rectangular grease reservoir (low level, 2-m12, 10mm cap)			
122591	230 VAC, 12.7 pint plastic rectangular grease reservoir (low level, 1-din, screw cap)			

For more details see Technical Bulletin #L12121 on www.graco.com - Instruction Manuals

Electric Pumps

Maxi-Flo

Lubrication Pumps



Works With:



Everything you need to get your Single Line Resistive Oil lubrication system installed and running quickly. A standard, compact package comes complete with reservoir, pump, gear motor, and choice of internal or remote control. Simple slide switches allow for easy setup of pump run cycle time. Bright LED indicators for low level and power allow for easy troubleshooting and verification.

Key Features

- Integrated control with manual run button for easy setup
- Compact design fits anywhere
- 500 psi rating for using with various orifice metering devices

Ordering Information and Technical Specifications

Part No.	Model Description	Max Pump Output/Stroke cm ³ (in ³)	Max Pump Output Volume cm ³ (in ³)	Max. Operating Pressure, bar (psi)	Lubrication Type
563379	115 VAC, 4 pint plastic rectangular oil reservoir, solid state timer control	0.165 (0.01)	1.64 (0.1)	34 (500)	Oil (60-30,000 SUS)
563376	115 VAC, 4 pint plastic rectangular oil reservoir, remote control				

For more details see Technical Bulletin #L13110 on www.graco.com - Instruction Manuals

Meter-Flo

Lubrication Pumps

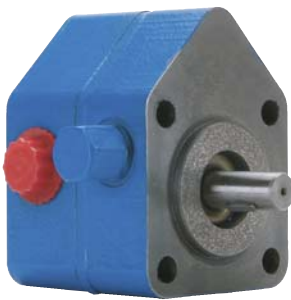

Works With:



The Meter-Flo direct drive pumps are ideal for applications requiring continuous oil delivery to up to 1000 lubrication points. With its solid pump housing and reservoir, these rugged gear pumps are designed for dependable operation in high demand applications. The gear pump is available with a direct-coupled 1/2 horsepower motor capable of 1725 RPM's with output volumes of 245 cubic inches per minute. Eleven different pump models to choose from.

Key Features

- Pump packages for even the largest applications—up to 1000 lube points!
- Rugged design for dependable service in high-demand applications

Ordering Information and Technical Specifications

Part No.	Model Description	Max. Lube Output Pressure, bar (psi)	Lubrication Type
557814	9 cu. In./min @ 1140 RPM - 14 cu. In./min @ 1725 RPM	21-104 (300-1500*)	Oil (300-3,000 SUS)
557813	18 cu. In./min @ 1140 RPM - 30 cu. In./min @ 1725 RPM		
557815	56 cu. In./min @ 1140 RPM - 84 cu. In./min @ 1725 RPM		
557816	76 cu. In./min @ 1140 RPM - 117 cu. In./min @ 1725 RPM		
557817	111 cu. In./min @ 1140 RPM - 168 cu. In./min @ 1725 RPM		
557820	161 cu. In./min @ 1140 RPM - 245 cu. In./min @ 1725 RPM		

* NOTE: Internal pressure relief to 1200 psi

For more details see Technical Bulletin #L12611 and L12608 on www.graco.com - Instruction Manuals

Electric Pumps

Lubrication Pumps

Modu-Flo



Works With:



The Modu-Flo system is ideal for applications where minimizing downtime is critical. Customizing is easy—just mix and match pumps, reservoir and manifolds in any configuration to meet any application. Replace the pump or reservoir, without disconnecting lubrication lines. Electric pumps available for use with AC or DC supply voltage make Modu-Flo the right solution for any automated electric lubrication system.

Key Features

- Modular system design allows configurations to work in all applications
- Easy to standardize on components and reduce inventory
- Adjustable pump output for fast, convenient customization

Ordering Information and Technical Specifications

Part No.	Model Description	Max Pump Output Volume cm ³ (in ³)	Max. Lube Output Pressure, bar (psi)	Lubrication Type
563356	24 VDC with 20 ft cable (no reservoir)	0.29 (4.7)	172 (2500)	Oil or Grease Up to NLGI #2
563346	115 VAC with 20 ft cable (no reservoir)	0.58 (9.5)		
564371	115 VAC without 20 ft cable (no reservoir)	0.58 (9.5)		

For more details see Technical Bulletin #L12011 on www.graco.com - Instruction Manuals

Lubrication Pumps

Thrif-T Luber



Works With:



The perfect fit for entry-level, Single Line Resistive orifice lubrication systems. A complete electric package includes pump, reservoir and integrated control (remote version optional) for fast and easy installation. Can pay for itself right away!

Key Features

- Use with Thrif-T Luber orifice dispensers for a complete system
- Big on features—low on price!
- Compact, turnkey system solution

Ordering Information and Technical Specifications

Part No.	Model Description	Max Pump Output Volume cm ³ (in ³)	Max. Lube Output Pressure, bar (psi)	Lubrication Type
564067	115 VAC pump, 4 pint plastic rectangular oil reservoir, remote control	6.9 (0.42)	10 (150)	Oil
564068	115VAC pump, 4 pint plastic oil reservoir, timer control			(100-10,000 SUS)

For more details see Technical Bulletin #LTL400 on www.graco.com - Instruction Manuals

Hydraulic Pumps

Modu-Flo

Lubrication Pumps



Works With:



The Modu-Flo system is ideal for applications where minimizing downtime is critical. Customizing is easy—just mix and match pumps, reservoir and manifolds in any configuration to meet any application. Replace the pump or reservoir without disconnecting lubrication lines. Choose from a wide variety of hydraulic pumps that operate with grease or oil.

Key Features

- Modular system design allows configurations to work in all applications
- Easy to standardize on components and reduce inventory
- Adjustable pump output for fast, convenient customization

Ordering Information and Technical Specifications

Part No.	Model Description	Max Pump Output/ Stroke cm ³ (in ³)	Ratio	Max. Hydraulic Pressure, bar (psi)	Lubrication Type
563305	HLJ-5 pump, double acting (no reservoir)	0.16-0.49 (0.01-0.03)	5.5:1	13.8-137.9 (200-2000)	Oil or grease up to NLGI #2
563345	HLJ-5X pump, double acting (no reservoir)	0.49-1.5 (0.03-.09)	2.2:1	13.8-207 (200-3000)	
563307	HLJ-25 pump, double acting (no reservoir)	.49-2.0 (0.03-0.12)	5.5:1	13.8-137.9 (200-2000)	

For more details see Technical Bulletin #L12000 on www.graco.com - Instruction Manuals

Manual Pumps

Thrif-T Luber

Lubrication Pumps



Works With:



A simple and effective positive displacement pump that delivers up to 0.50 in³ per stroke. Compact design easily mounts on any piece of equipment. A spring return drives the piston for controlled lubrication delivery.

Key Features

- Cost-effective solution with centralized system benefits
- Compact design fits anywhere
- Easy to setup and use

Ordering Information and Technical Specifications

Part No.	Model Description	Max Pump Output/Stroke cm ³ (in ³)	Max. Operating Pressure, bar (psi)	Lubrication Type
564012	Hand pump, 4 pint plastic rectangular oil reservoir	8.2 (0.5)	5 (75)	(100-10,000 SUS)

For more details see Technical Bulletin #LTL400 on www.graco.com - Instruction Manuals

Manual Pumps

PH Pump

Lubrication Pumps



Works With:



A great entry-level solution for your centralized lubrication system, the PH Pump gives you manual lubrication delivery when you need it. An easy-to-operate lever arm delivers up to 0.15 in³ with one full stroke, while sturdy construction is designed for years of use.

Key Features

- Cost-effective solution with centralized system benefits
- Great entry-level solution!
- Works with any type of centralized system
- Two outlet valve options for use with dual line systems

Part No.	Model Description	Max Pump Output/ Stroke cm ³ (in ³)	Max. Lube Output Pressure, bar (psi)	Lubrication Type
563393	Pump (w/out reservoir)	2.46 (0.15)	207 (3000)	Oil, Grease up to NLGI #2
564378	Pump w/5 pint plastic cylindrical oil reservoir			
564379	Pump w/5 lb. plastic cylindrical grease reservoir			
564381	Pump w/5 lb. metal cylindrical grease reservoir			
564389	Pump w/6 lb. plastic cylindrical grease reservoir			
564383	Pump w/12 lb. plastic cylindrical grease reservoir			
564386	Pump w/20 lb. plastic cylindrical grease reservoir			
564385	Pump w/20 pint plastic cylindrical oil reservoir			
564384	Pump w/12 lb. metal cylindrical grease reservoir			
564387	Pump w/6 pint plastic cylindrical oil reservoir			

For more details see Technical Bulletin #L12415 on www.graco.com - Instruction Manuals

Manual Grease Gun

Lubrication Pumps



Works With:



A simple, compact, cost-effective way to deliver oil or grease. Ideal for purging existing centralized systems when changing lubrication or performing maintenance. The Manual Grease Gun is also a troubleshooting tool for locating leaks or plugged lines, or for priming your new lubrication system upon start-up.

Key Features

- Cost-effective solution with centralized system benefits
- Ideal for troubleshooting and system testing
- Handy carrying case for easy portability

Ordering Information and Technical Specifications

Part No.	Model Description	Max Pump Output/ Stroke cm ³ (in ³)	Max. Output Pressure, bar (psi)	Lubrication Type
562857	Pump package with carrying case	1.5 (0.09)	345 (5000)	Oil or grease up to NLGI #2

For more details see Technical Bulletin #L12405 on www.graco.com - Instruction Manuals

Manual Pumps

LubriSystem

Lubrication Pumps



Works With:



The LubriSystem hand pump package offers versatility for use in any application, large or small! Great for operation with Injectors or Piston Distributors, with oil or grease. Sturdy construction of aluminum and steel to provide years of service. Compact design can be used in areas where space is limited. Rugged bracket allows the pump package to be mounted in place in any application.

Key Features

- Bracket-mount design for easy installation
- Rugged design for years of operation
- Built-in pressure venting for use with injectors

Ordering Information and Technical Specifications

Part No.	Model Description	Max Pump Output/ Stroke cm ³ (in ³)	Max. Output Pressure, bar (psi)	Lubrication Type
564421	Hand pump, 6 lb. plastic cylindrical grease reservoir, 3000 psi gauge	2 (0.13)	207 (3000)	Grease up to NLGI #1
564422	Hand pump, 12 lb. plastic cylindrical grease reservoir, 3000 psi gauge			Grease up to NLGI #1
564423	Hand pump, 20 lb. plastic cylindrical grease reservoir, 3000 psi gauge			Grease up to NLGI #1
564419	Hand pump, 12 Pint plastic cylindrical oil reservoir, 3000 psi gauge			Oil
564420	Hand pump, 20 Pint plastic cylindrical oil reservoir, 3000 psi gauge			Oil
563580	Hand pump body (no reservoir)			Grease up to NLGI #1

For more details see Technical Bulletin #L12100 on www.graco.com - Instruction Manuals

Mechanical Pumps

LubeMaster Ratchet Pump

Lubrication Pumps



Works With:



Lubricates only while the machine is running! The Lubemaster Clutch Drive is a rugged, reliable pump powered mechanically by the machine using the lubrication. This pump is ideal for applications where lubrication cycles vary and are unpredictable.

The TRABON Clutch Drive Lubemaster is a rugged, reliable pump designed to be driven mechanically by the machine being lubricated. The Lubemaster can be used with Series Progressive, Reversible or Bi-Flo systems.

Ordering Information and Technical Specifications

Degrees of Throw	Effective Ratio	Impulses per minute	Pump strokes per hour	Output per hour	
				Minimum	Maximum
12°	30:1	5 min	10	.100 cu. in. (1.639 cu.cm)	.500 cu. in. (8.195 cu.cm)
60°	6:1	150 Max.	1500	15.00 cu. in. (245.85 cu.cm)	75.00 cu. in. (1229.25 cu.cm)

For more details see Technical Bulletin #L12405 on www.graco.com - Instruction Manuals

Ordering Information

Accessories

Modu-Flo and E-Series Reservoirs	
563359	4 pint rectangular plastic oil reservoir
562891	5 pint cylindrical plastic oil reservoir
562904	6 pint cylindrical plastic oil reservoir
562889	12 pint cylindrical plastic oil reservoir
562890	20 pint cylindrical plastic oil reservoir
563320	24 pint rectangular metal oil reservoir
563319	12 pint rectangular metal oil reservoir
563321	40 pint rectangular metal oil reservoir
562910	3 lb cylindrical plastic grease reservoir
562888	5 lb cylindrical plastic grease reservoir
562905	6 lb cylindrical plastic grease reservoir
562884	12 lb cylindrical plastic grease reservoir
562885	20 lb cylindrical plastic grease reservoir
562906	6 lb cylindrical metal grease reservoir
562886	12 lb cylindrical metal grease reservoir
562887	20 lb cylindrical metal grease reservoir
Modu-Flo Manifolds (Baseplates)	
563333	Pump to reservoir manifold, NPT with liquid filled gauge, fill check, outlet check, & blowout
563329	Pump to reservoir manifold, NPT (no hardware or fittings)
563355	Pump to reservoir manifold, SAE, with dry gauge, fill check, outlet check, and blowout
563324	Pump to reservoir manifold, NPT, with dry gauge, fill check, outlet check, & blowout
563331	Pump to reservoir manifold, NPT, with dry gauge, fill check, outlet check, & tubed blowout
563323	Remote pump manifold, NPT, with fill, check, outlet check, and blowout
563330	Remote pump manifold, NPT, with fill, check, outlet check, and tubed blowout
Modu-Flo and E-Pump Spare Parts and Accessories	
563378	Low level switch kit, 10 watt, 4 pint rectangular oil reservoir
557826	Replacement switch for P/N 563378
563014	Low level switch, 10 watt, for 6 pint cylindrical oil reservoirs
563015	Low level switch, 10 watt, for 5 and 20 pint cylindrical oil reservoir
557825	Replacement switch for P/N's 563014, 563015, 563016
563322	Low level switch, 15 amp, for all grease reservoirs (except 3 lb)
557781	Replacement switch for P/N 563322
563316	Low level switch, 15 amp, for 5 and 12 pint cylindrical oil reservoirs
563318	Low level switch, 15 amp, for 6 pint cylindrical oil reservoir
563317	Low level switch, 15 amp, for 20 pint cylindrical oil reservoir
563016	Low level switch, 10 watt, for 20 pint cylindrical oil reservoir
563909	E-pump spare part repair kit (contains O-rings, gaskets, springs, and retainers)
563328	Pressure switch for all reservoirs
563326	1,450 psi blowout switch 6, 12, 20 pint/pound cylindrical reservoir
563179	1,450 psi standard blowout disk
563325	1,450 psi blowout switch 5 pt/lb cylindrical reservoir
563327	1,450 psi blowout switch for all tanks
563315	115 VAC, 2-position, 3-way pneumatic solenoid valve
563312	Replacement solenoid valve for 563315
563332	24 VDC, 2-position, 3-way pneumatic solenoid valve
563349	24 VDC, 2-position, 3-way pneumatic solenoid valve, with Hirschman connection
563339	115 VAC timer kit for all tanks
563340	115 VAC timer kit for 5 pt/lb cylindrical reservoirs
563342	115 VAC timer kit for 6, 12, 20 pt/lb cylindrical reservoirs
563341	115 VAC timer kit for 6, 12, 20 pt/lb cylindrical reservoirs
563902	AL-5M seal kit
563903	AL-25M seal kit
563904	AL-50M seal kit
563905	HL-5M seal kit
563906	HL-25M seal kit
563925	HL-5X seal kit
563337	Pump mounting kit (contains mounting screws and O-rings)
562901	5 pt/lb plastic replacement reservoir assembly (4 in O.D. x 13 in long)
562909	6 pt/lb plastic replacement reservoir assembly (6 in O.D. x 8.5 in long)
562902	12 pt/lb plastic replacement reservoir assembly (6 in O.D. x 13 in long)
562903	20 pt/lb plastic replacement reservoir assembly (6 in O.D. x 20 in long)
564270	12 lb metal replacement reservoir assembly (6 in O.D. x 13 in long)
564271	20 lb metal replacement reservoir assembly (6 in O.D. x 20 in long)
G3 Accessories	
571061	Vent Valve Kit, 12 VDC - vent valve, adjustable pressure relief (500-5000 psi, 35-345 bar), pressure gauge, zerk fitting
571029	Vent Valve Kit, 24 VDC/90-240 VAC - vent valve, adjustable pressure relief (500-5000 psi, 35-345 bar), pressure gauge, zerk fitting. Also for G3 Max control AC pumps

Complete Your System

Modu-Flo and E-Series Reservoirs	
563359	4 pint rectangular plastic oil reservoir
562891	5 pint cylindrical plastic oil reservoir
562904	6 pint cylindrical plastic oil reservoir
562889	12 pint cylindrical plastic oil reservoir
562890	20 pint cylindrical plastic oil reservoir
563320	24 pint rectangular metal oil reservoir
563319	12 pint rectangular metal oil reservoir
563321	40 pint rectangular metal oil reservoir
562910	3 lb cylindrical plastic grease reservoir
562888	5 lb cylindrical plastic grease reservoir
562905	6 lb cylindrical plastic grease reservoir
562884	12 lb cylindrical plastic grease reservoir
562885	20 lb cylindrical plastic grease reservoir
562906	6 lb cylindrical metal grease reservoir
562886	12 lb cylindrical metal grease reservoir
562887	20 lb cylindrical metal grease reservoir
Modu-Flo Manifolds (Baseplates)	
563333	Pump to reservoir manifold, NPT with liquid filled gauge, fill check, outlet check, & blowout
563329	Pump to reservoir manifold, NPT (no hardware or fittings)
563355	Pump to reservoir manifold, SAE, with dry gauge, fill check, outlet check, and blowout
563324	Pump to reservoir manifold, NPT, with dry gauge, fill check, outlet check, & blowout
563331	Pump to reservoir manifold, NPT, with dry gauge, fill check, outlet check, & tubed blowout
563323	Remote pump manifold, NPT, with fill, check, outlet check, and blowout
563330	Remote pump manifold, NPT, with fill, check, outlet check, and tubed blowout
Modu-Flo and E-Pump Spare Parts and Accessories	
563378	Low level switch kit, 10 watt, 4 pint rectangular oil reservoir
557826	Replacement switch for P/N 563378
563014	Low level switch, 10 watt, for 6 pint cylindrical oil reservoirs
563015	Low level switch, 10 watt, for 5 and 20 pint cylindrical oil reservoir
557825	Replacement switch for P/N's 563014, 563015, 563016
563322	Low level switch, 15 amp, for all grease reservoirs (except 3 lb)
557781	Replacement switch for P/N 563322
563316	Low level switch, 15 amp, for 5 and 12 pint cylindrical oil reservoirs
563318	Low level switch, 15 amp, for 6 pint cylindrical oil reservoir
563317	Low level switch, 15 amp, for 20 pint cylindrical oil reservoir
563016	Low level switch, 10 watt, for 20 pint cylindrical oil reservoir
563909	E-pump spare part repair kit (contains O-rings, gaskets, springs, and retainers)
563328	Pressure switch for all reservoirs
563326	1,450 psi blowout switch 6, 12, 20 pint/pound cylindrical reservoir
563179	1,450 psi standard blowout desk
563325	1,450 psi blowout switch 5 pt/lb cylindrical reservoir
563327	1,450 psi blowout switch for all tanks
563315	115 VAC, 2-position, 3-way pneumatic solenoid valve
563312	Replacement solenoid valve for 563315
563332	24 VDC, 2-position, 3-way pneumatic solenoid valve
563349	24 VDC, 2-position, 3-way pneumatic solenoid valve, with Hirschman connection
563339	115 VAC timer kit for all tanks
563340	115 VAC timer kit for 5 pt/lb cylindrical reservoirs
563342	115 VAC timer kit for 6, 12, 20 pt/lb cylindrical reservoirs
563341	115 VAC timer kit for 6, 12, 20 pt/lb cylindrical reservoirs
563902	AL-5M seal kit
563903	AL-25M seal kit
563904	AL-50M seal kit
563905	HL-5M seal kit
563906	HL-25M seal kit
563925	HL-5X seal kit
563337	Pump mounting kit (contains mounting screws and O-rings)
562901	5 pt/lb plastic replacement reservoir assembly (4 in O.D. x 13 in long)
562909	6 pt/lb plastic replacement reservoir assembly (6 in O.D. x 8.5 in long)
562902	12 pt/lb plastic replacement reservoir assembly (6 in O.D. x 13 in long)
562903	20 pt/lb plastic replacement reservoir assembly (6 in O.D. x 20 in long)
564270	12 lb metal replacement reservoir assembly (6 in O.D. x 13 in long)
564271	20 lb metal replacement reservoir assembly (6 in O.D. x 20 in long)
G3 Accessories	
571061	Vent Valve Kit, 12 VDC - vent valve, adjustable pressure relief (500-5000 psi, 35-345 bar), pressure gauge, zerk fitting
571029	Vent Valve Kit, 24 VDC/90-240 VAC - vent valve, adjustable pressure relief (500-5000 psi, 35-345 bar), pressure gauge, zerk fitting. Also for G3 Max control AC pumps
571028	Adjustable return to reservoir pressure kit (500-5000 psi, 35-345 bar)
571041	G3 pump element kit (adjustable output)
G3 Accessories (continued)	
571032	Remote manual run kit, 12 VDC
571033	Remote manual run kit, 24 VDC/90-240 VAC
Injecto-Flo (EO-1, AO-1, EO-3) Spare Parts and Accessories	
556013	EO-1 gear pump
556011	115 VAC replacement motor for Injecto-Flo pumps
556012	230 VAC replacement motor for Injecto-Flo pumps
556016	Low level switch assembly for all 6 and 12 liter Injecto-Flo pump assemblies
556014	Suction strainer for Injecto-Flo pump
563332	24 VDC, 2 Position, 3-Way Pneumatic Solenoid Valve
Injecto-Flo II Reservoirs	
122911	3 Liter plastic oil reservoir (no cover)
15X748	6 Liter plastic oil reservoir (no cover)
LubeMaster Reservoirs	
562892	12 pint plastic oil reservoir
562893	20 pint plastic oil reservoir
562894	12 pint metal oil reservoir
562896	12 lb plastic grease reservoir
562897	20 lb plastic grease reservoir
562899	20 lb metal grease reservoir
562895	20 pint metal oil reservoir
562898	12 lb metal grease reservoir
LubeMaster Spare Parts and Accessories	
557271	Replacement motor - 1/2 HP, 115/230 VAC, single phase, 60 Hz, 1725 RPM
557270	Replacement motor - 1/2 HP, 230/460 VAC, 3-phase, 60 Hz, 1725 RPM
557272	Replacement motor - 1/2 HP, 115/230 VAC, single phase, 60 Hz, 1140 rpm
557273	Replacement motor - 1/2 HP, 230/460 VAC, 3-phase, 60 Hz, 1140 RPM
563380	Replacement pump (no reservoir)

Accessories

563921	LubeMaster seal repair kit
563916	LubeMaster output manifold kit
563915	LubeMaster drive repair kit
557713	Pressure gauge; 0-3,000 psi liquid filled
563179	Standard blowout oil; 1,450 psi
563184	Standard blowout grease; 2,350 psi
563384	High pressure blowout switch oil; 1,450 psi
563385	High pressure blowout switch grease; 2,350 psi
563316	Low level switch, 15 amp, SPDT, for 12 pint oil reservoir
563317	Low level switch, 15 amp, SPDT, for 20 pint oil reservoir
563322	Low level switch, SPDT, for 12/20 lb. grease reservoir
563016	Low level switch, 10 watt, SPST, for 20 pint oil reservoir
564377	Low level switch, 15 amp, SPDT, for 12/20 lb grease reservoir, explosion proof, class 1 groups C & D, class 2 groups E, F, and G
563015	Low level switch, 10 watt, SPST, for 12 pint oil reservoir
563383	Mechanical clutch drive with arm
563388	Mounting Base with 10:1 drive reduction, floor mounting
563386	Mounting Base with 10:1 drive reduction, wall mounting
563389	Mounting Base with 60:1 drive reduction, floor mounting
563387	Mounting Base with 60:1 drive reduction, wall mounting
LubriSystem Reservoirs: Pneumatic/Electric	
564265	6 pint plastic oil reservoir
562892	12 pint plastic oil reservoir
562893	20 pint plastic oil reservoir
562907	6 lb plastic grease reservoir
562896	12 lb plastic grease reservoir
562897	20 lb plastic grease reservoir
562898	12 lb metal grease reservoir
562899	20 lb metal grease reservoir
LubriSystem Reservoirs: Hand Pumps	
562904	6 pint plastic oil reservoir
562889	12 pint plastic oil reservoir
562890	20 pint plastic oil reservoir
562905	6 lb plastic grease reservoir
562884	12 lb plastic grease reservoir
562885	20 lb plastic grease reservoir
LubriSystem Spare Parts and Accessories	
563014	Low level switch for LubriSystem 6 pt oil reservoir, 10 watt
563015	Low level switch for LubriSystem 12 pt oil reservoir, 10 watt
563322	Low level switch for any LubriSystem grease reservoir
563016	Low level switch for LubriSystem 20 pt oil reservoir, 10 watt
563315	115 VAC solenoid valve, for LubriSystem
563332	24 VDC solenoid valve, for LubriSystem
563579	LubriSystem standard air operated pump body, 9:1 ratio (no reservoir)
563580	LubriSystem hand pump body (no reservoir)
Maxi-Flo Reservoirs	
563930	Electric Maxi-Flo replacement reservoir kit
Maxi-Flo Spare Parts/Accessories	
557826	Replacement switch, low level
563375	Maxi-Flo relief valve, 600 psi
Meter-Flo Reservoirs	
564340	30 gallon metal oil reservoir
Meter-Flo Replacement Pumps	
558949	56 cu. In./min @ 1140 RPM - 84 cu. In./min @ 1725 RPM
557816	76 cu. In./min @ 1140 RPM - 117 cu. In./min @ 1725 RPM
558950	76 cu. In./min @ 1140 RPM - 117 cu. In./min @ 1725 RPM
Meter-Flo Replacement Pumps (continued)	
558951	111 cu. In./min @ 1140 RPM - 168 cu. In./min @ 1725 RPM
557818	26 cu. In./min @ 1140 RPM - 40 cu. In./min @ 1725 RPM
557819	9 cu. In./min @ 1140 RPM - 14 cu. In./min @ 1725 RPM
557820	161 cu. In./min @ 1140 RPM - 245 cu. In./min @ 1725 RPM
558955	161 cu. In./min @ 1140 RPM - 245 cu. In./min @ 1725 RPM
558289	Replacement Motor, 1/4 HP, 115/230VAC, single-phase, 60Hz, 1725 RPM, TENV
563557	Meter-Flo Paddle Base w/ pump P/N 557814 (no Motor, no Reservoir)
564411	Meter-Flo Paddle Base w/ pump P/N 557813 (no Motor, no Reservoir)
558290	Replacement Motor, 1/4 HP, 230/460VAC, 3-phase, 60Hz, 1725 RPM, TENV
Meter-Flo Spare Parts and Accessories	
561063	Meter-Flo paddle base
561067	Mounting bracket, for Meter-Flo paddle base and pump
563303	Coupling for, Meter-Flo paddle base and pump
557067	Coupling guard, for Meter-Flo paddle base and pump
563303	Meter-Flo conversion coupling kit
Miniature Meter-Flo Spare Parts and Accessories	
564415	Gear motor reduction assembly, 14 cu in/min. flow rate (with pump)
564412	Gear motor reduction assembly, 1 cu in/min. flow rate (with pump)
564413	Gear motor reduction assembly, 5 cu in/min. flow rate (with pump)
557828	High pressure switch, moisture resistant, 324 bar (4700 psi) max
557825	Low level switch
557810	Replacement suction strainer
563558	Relief valve
PH Pump Reservoirs	
562891	5 pint plastic oil reservoir
562904	6 pint plastic oil reservoir
562889	12 pint plastic oil reservoir
562890	20 pint plastic oil reservoir
562888	5 lb plastic grease reservoir
562905	6 lb plastic grease reservoir
562884	12 lb plastic grease reservoir
562885	20 lb plastic grease reservoir
564264	5 lb metal grease reservoir
562886	12 lb metal grease reservoir
PH Pump Spare Parts and Accessories	
563160	Automatic 2,500 psi relief valve, for PH pump
563924	PH manual pump body repair kit
557864	Pressure gauge (3000 psi)
Thrif-T Luber Reservoirs	
564439	Replacement reservoir kit for 115 VAC Thrif-T Luber
Thrif-T Luber Spare Parts and Accessories	
564065	Replacement Thrif-T Luber pump
557641	Replacement motor for 115 VAC Thrif-T Luber electric pumps
558031	Replacement timer board for 115 VAC Thrif-T Luber timers
564066	Thrif-T Luber low level switch kit
557826	Replacement low level switch
558296	Thrif-T Luber pressure gauge
564053	Thrif-T Luber filters
563162	Thrif-T Luber relief valve, 150 psi
556677	Rubber plug for Thrif-T luber reservoir
561143	TLTP-25, Thrif-T Luber 5/32 in plastic tubing (25 ft)
MSA Spare Parts and Accessories	
563912	MSA-10 repair kit
563072	Air inlet restrictor valve
563913	MSA-100 repair kit



ABOUT GRACO

Founded in 1926, Graco is a world leader in fluid handling systems and components. Graco products move, measure, control, dispense and apply a wide range of fluids and viscous materials used in vehicle lubrication, commercial and industrial settings.

The company's success is based on its unwavering commitment to technical excellence, world-class manufacturing and unparalleled customer service. Working closely with qualified distributors, Graco offers systems, products and technology that set the quality standard in a wide range of fluid handling solutions. Graco provides equipment for spray finishing, protective coating, paint circulation, lubrication, and dispensing sealants and adhesives, along with power application equipment for the contractor industry. Graco's ongoing investment in fluid management and control will continue to provide innovative solutions to a diverse global market.

GRACO LOCATIONS

CONTACT

MAILING ADDRESS
P.O. Box 1441
Minneapolis, MN 55440-1441
Tel: 612.623.6000
Fax: 612.623.6777

AMERICAS

MINNESOTA
Worldwide Headquarters
Graco Inc.
88-11th Avenue N.E.
Minneapolis, MN 55413

EUROPE

BELGIUM
European Headquarters
Graco N.V.
Industrieterrein-Oude Bunders
Slakweidestraat 31
3630 Maasmechelen,
Belgium
Tel: 32.89.770.700
Fax: 32.89.770.777

ASIA PACIFIC

JAPAN
Graco K.K.
1-27-12 Hayabuchi
Tsuzuki-ku
Yokohama City, Japan 2240025
Tel: 81.45.593.7300
Fax: 81.45.593.7301

ASIA PACIFIC

CHINA
Graco Hong Kong Ltd.
Shanghai Representative Office
Building 7
1029 Zhongshan Road
South Huangpu District
Shanghai 200011
The People's Republic of China
Tel: 86 21 649 50088
Fax: 86 21 649 50077

ASIA PACIFIC

KOREA
Graco Korea Inc.
Choheung Bank Building
4th Floor #1599
Gwanyang-Dong, Dongan-Ku,
Anyang-Si, Gyunggi-Do,
Korea 431-060
Tel: 82(Korea).31.476.9400
Fax: 82(Korea).31.476.9801

All written and visual data contained in this document are based on the latest product information available at the time of publication.
Graco reserves the right to make changes at any time without notice.

Graco is certified ISO 9001.

Europe
+32 89 770 700
FAX +32 89 770 777
WWW.GRACO.COM